

INTORQ

setting the standard

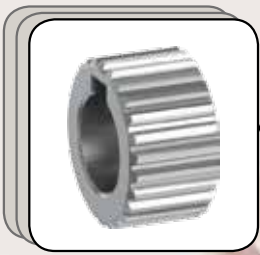

⋮

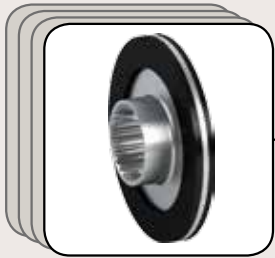
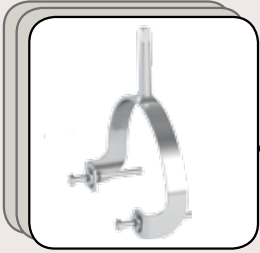
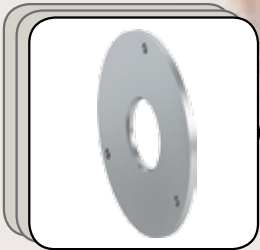

Go!

Your BFK470



Spring-applied brake BFK470

The IP66 modular system

We set the standards

The INTORQ brand stands for reliable brake solutions of the highest standard. Whether in cranes, wind turbines or industrial trucks – INTORQ products are used in the most diverse of applications. Rely on us to create the right solution for your drive – individually and reliably.

With its high number of variants, INTORQ's range of modular products is used in many motors and geared motors and has set standards worldwide. With the establishment of facilities in Shanghai, Atlanta and Pune we have also consistently expanded our international presence. So wherever you are in the world, our network of sales and service staff is always close at hand to support you.

INTORQ at a glance

- Electromagnetic brakes and clutches
- Configurable standard solutions and custom-made solutions
- Development and production centred in Aerzen
- Fast delivery times worldwide thanks to production sites in Shanghai, Atlanta and Pune
- 51 million euros a year sales volume
- 800,000 units a year
- 13,000 square metres production area
- 250 employees
- Market leader with 63 sales partners in 49 countries



Heavy demands? The BFK470 is the IP66 spring-applied brake for you

BFK470, the brake series from INTORQ, is a scalable system of modules designed for universal use. It is ideal for special areas of operation that place heavy demands on the enclosure and the braking torque tolerance. We have tailored our products to fulfil market requirements. This means we can provide you with what you need. The INTORQ modular system is a unique solution in the market, and it is always guaranteed to be available, quickly and globally. Another advantage is the outstanding reaction time in the acquisition phase.

The new series of brakes is a fusion of the BFK460 and the BFK461, which have been established in the market for over a decade, and it has been enhanced with enclosures that comply with IP66.



Scalable in all directions

Increase in power

The BFK470 series comes in seven sizes, with braking torques from 2 – 370 Nm. The BFK470 meets the market's need for ever higher torques by providing a significant increase in power.

Enclosure

The brake has been specially developed for operating ranges that make heavy demands on the enclosure. It complies with IP66, providing optimal protection against the ingress of dust and strong jets of water.

Braking torque tolerance

Solutions that are becoming more and more optimised require braking torques that are more and more precise. With its BFK470 series, INTORQ has redefined the limits of what is technically possible.

Long service life

As with all INTORQ products, it is the quality of the product that takes top priority. Further development of the mechanical design enables the BFK470 to withstand highest numbers of switching cycles.

Noise-reduced aluminium rotor

The BFK470 also comes with the option of a rotor and a toothed intermediate ring made of plastic. This significantly increases the service life.

Friction lining variants

In addition to our standard lining, we offer a number of special linings. They make it possible to achieve higher braking torques, stable static torques, high friction work and a longer service life.

Options

- Hand-release complying with IP66 enclosure, release direction on both sides
- Noise-reduced rotor
- Function monitoring through contactless proximity switch compliant with IP66 enclosure
- Non-standard voltages and bores available on request
- CCV (Cold Climate Version)
- Sealing cover
- Tachometer bores

Some call it an obsession with detail – we call it perfectionism

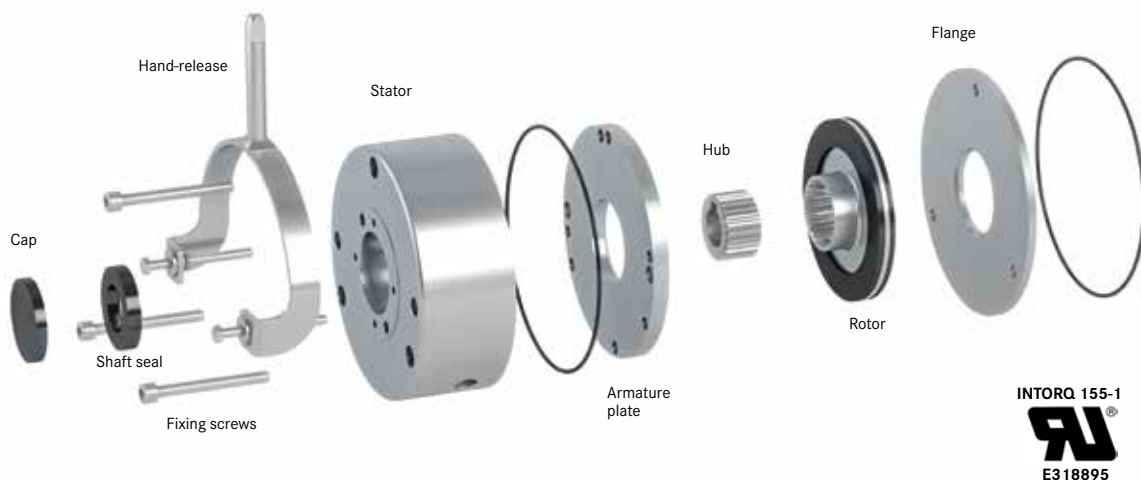



Rated torques

Rated torque $M_{r,N}$ [Nm] of the brake, rated value at a relative speed of 100 r/min

Size	06	08	10	12	14	16	18
Operating brake				12			
	2	3,5		15			
	2,5	5	9	18			
	3	6	11	23	40	55	100
	3,5	7	14	27	50	70	125
Holding brake with emergency stops	4	8	16	32	60	80	150
	4,5	10	18	36	65	90	165
	5,5	11	21	40	70	100	185
	6	12	23	45	75	105	200
	6,5	14	25	48	80	125	235
			28	50	100	150	250
On request for project solutions	up to 10	up to 17	up to 46	up to 68	up to 150	up to 200	up to 370

 Operating brake
(s_{limax} ca. 2.5 x s_{LN})

 Standard braking torque

 Holding brake with emergency stop (s_{limax} ca. 1.5 x s_{LN})

INTORQ GmbH & Co. KG
Germany

Postfach 1103
D-31849 Aerzen
Wülmser Weg 5
D-31855 Aerzen

Tel: +49 5154 70534-0
Fax: +49 5154 70534-200
E-mail info@intorq.de

INTORQ (Shanghai) CO., LTD
China

No. 600, Xin Yuan Nan Road,
Building No. 6 / Zone B
Nicheng town, Pudong
Shanghai, China 201306

Tel: +86 21 20363-810
Fax: +86 21 20363-805
E-mail info@cn.intorq.com

INTORQ US INC.
USA

300 Lake Ridge Drive SE
Smyrna, GA 30082

Tel: +1 678 236-0555
Fax: +1 678 309-1157
E-mail info@us.intorq.com

INTORQ India Pvt. Ltd.
India

Plot No. E-7/3, Chakan
Industrial Area, Phase 3,
Nighoje, Taluka-Khed,
Pune, 410501 Maharashtra

Tel: +91 21 3562-5500
E-mail info@intorq.in