

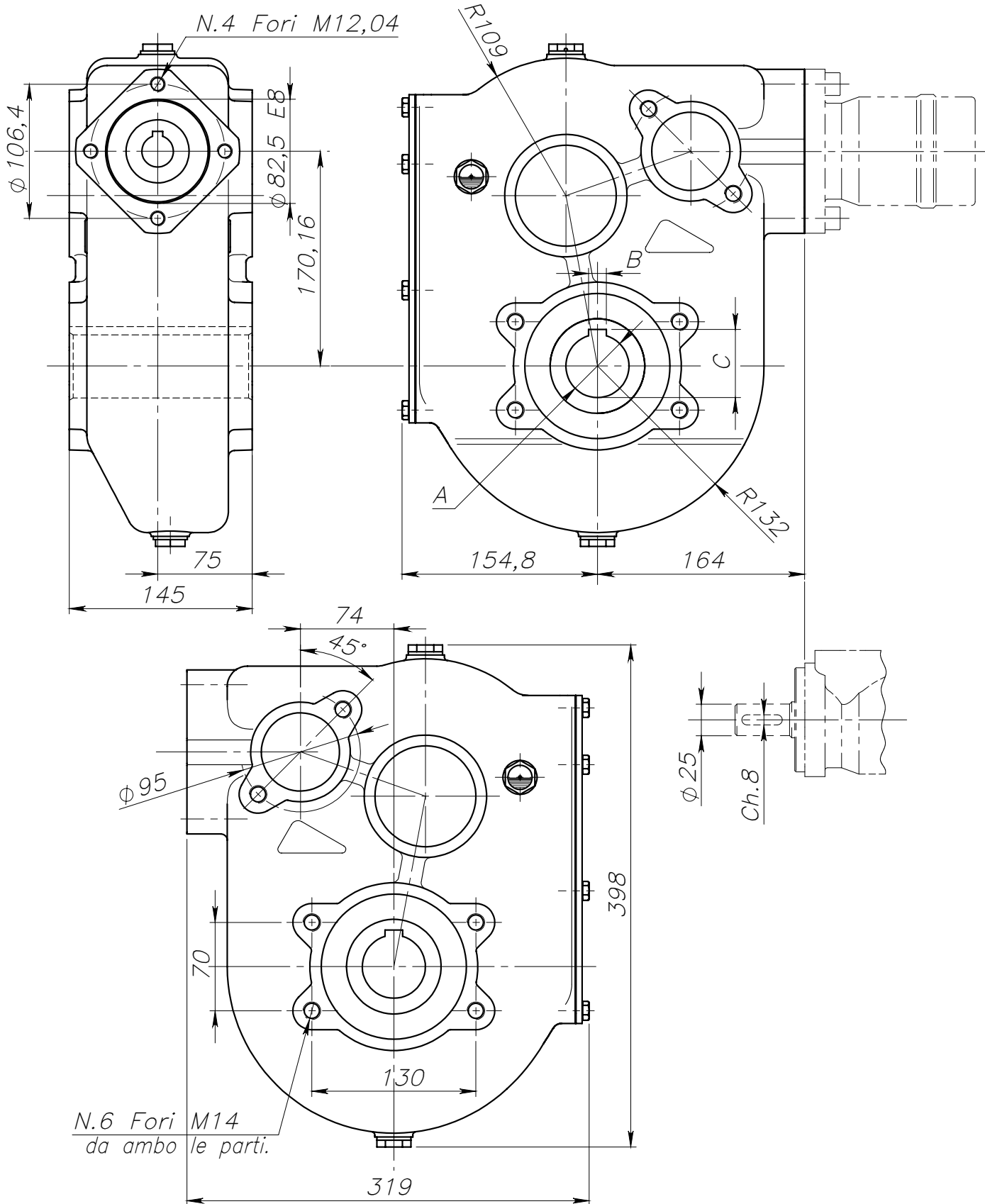

Riduttore RT 360



Marca	A E8	B E8	C	Peso kg	Rapporto	Mt in uscita Nm	Olio		Temperatura d'impiego:
							Tipo	Quantità kg	
17995	40	12	43,8						
17996	45	12	48,8	38	31,4:1	3500	SAE 90 EP	4,0	-20°C +80°C
17997	50	14	54						